

- 1 **For simple and quick connection of pneumatic circuits**
- 1 **Neat, compact design**
- 1 **Precision machined for complete reliability**
- 1 **Corrosion resistant, nickel plated**

**Technical Data****Medium:**

Compressed air

Operating Pressure:Vacuum - 15 bar
Dependent upon tube.**Operating Temperature:**-18°C to +70°C
Dependent upon tube.**Suitable Tube Sizes**4/2.5mm, 5/3mm, 6/4mm, Polyurethane
8/6mm, 10/8mm, 12/10mm, 15/12.5mm Extraflexible Nylon**Tubing Type:**

Polyurethane, Nylon 11*

*Consult our Technical Service for use with any other tubing.

Materials

Nut & body are nickel plated brass

'O' ring to NBR 70

Sealing washers - polyamide 66





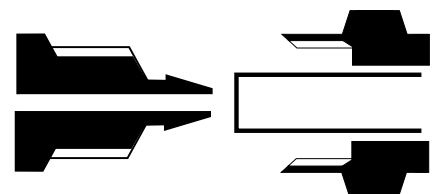

Ordering Information

To order, quote appropriate product number from the tables on the following pages.













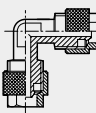

Straight Adaptors and Connectors

<p>STRAIGHT MALE ADAPTOR taper BSP</p>  <p>24125</p> <p>Page 9.5.001.03</p>	<p>STRAIGHT MALE ADAPTOR parallel BSP</p>  <p>24225</p> <p>Page 9.5.001.03</p>	<p>STRAIGHT MALE ADAPTOR with metric thread</p>  <p>24225</p> <p>Page 9.5.001.03</p>	<p>STRAIGHT FEMALE BSP ADAPTOR</p>  <p>24226</p> <p>Page 9.5.001.03</p>	<p>STRAIGHT CONNECTOR</p>  <p>24020</p> <p>Page 9.5.001.04</p>	<p>BULKHEAD CONNECTOR tube to tube</p>  <p>24029</p> <p>Page 9.5.001.04</p>	
--	--	--	---	--	---	--









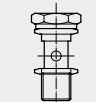
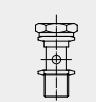

Elbow Connectors and Adaptors

<p>ELBOW MALE ADAPTOR taper BSP</p>  <p>24145</p> <p>Page 9.5.001.04</p>	<p>ELBOW FEMALE BSP ADAPTOR</p>  <p>24246</p> <p>Page 9.5.001.04</p>	<p>ELBOW CONNECTOR</p>  <p>24040</p> <p>Page 9.5.001.04</p>	<p>SWIVEL ELBOW ADAPTOR</p>  <p>24247</p> <p>Page 9.5.001.04</p>	<p>ELBOW BANJO ASSEMBLY</p>  <p>24A51</p> <p>Page 9.5.001.08</p>		
---	--	---	--	--	--	--

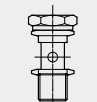
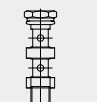
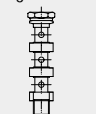
TEE Connectors and Adaptors

<p>TEE MALE BSP ADAPTOR taper - centre leg</p>  <p>24165</p> <p>Page 9.5.001.05</p>	<p>TEE MALE BSP ADAPTOR taper - off set leg</p>  <p>24175</p> <p>Page 9.5.001.05</p>	<p>TEE CONNECTOR</p>  <p>24060</p> <p>Page 9.5.001.05</p>	<p>EQUAL CROSS CONNECTOR</p>  <p>24090</p> <p>Page 9.5.001.05</p>	<p>TEE BANJO ASSEMBLY</p>  <p>24A71</p> <p>Page 9.5.001.08</p>		
--	--	---	---	--	--	--

Banjo Bodies and Bolts & Accessories

<p>SINGLE BANJO BODY</p>  <p>24051</p> <p>Page 9.5.001.05</p>	<p>DOUBLE BANJO BODY</p>  <p>24071</p> <p>Page 9.5.001.05</p>	<p>BANJO STEM SINGLE short bolt</p>  <p>24A00</p> <p>Page 9.5.001.06</p>	<p>BANJO STEM DOUBLE short bolt</p>  <p>24B00</p> <p>Page 9.5.001.06</p>	<p>BANJO STEM TRIPLE short bolt</p>  <p>24C00</p> <p>Page 9.5.001.06</p>	<p>BANJO STEM SINGLE long bolt</p>  <p>24A00</p> <p>Page 9.5.001.06</p>	<p>BANJO STEM DOUBLE long bolt</p>  <p>24B00</p> <p>Page 9.5.001.06</p>
<p>BANJO STEM TRIPLE long bolt</p>  <p>24C00</p> <p>Page 9.5.001.06</p>	<p>BANJO FLOW REGULATOR screwdriver regulation</p>  <p>24K51</p> <p>Page 9.5.001.07</p>	<p>BANJO FLOW REGULATOR regulating out bolt</p>  <p>24K</p> <p>Page 9.5.001.07</p>	<p>BANJO FLOW REGULATOR bi-directional flow bolt</p>  <p>24M</p> <p>Page 9.5.001.07</p>	<p>BANJO FLOW REGULATOR regulating in bolt</p>  <p>24L</p> <p>Page 9.5.001.07</p>	<p>TUBING NUT</p>  <p>24001</p> <p>Page 9.5.001.08</p>	<p>PLUG</p>  <p>24005</p> <p>Page 9.5.001.08</p>



Method of Assembly

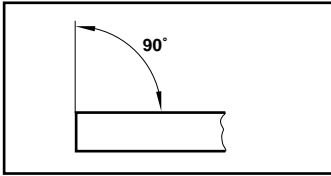

1. Ensure that the end of the tube is cut square and is free from burrs.

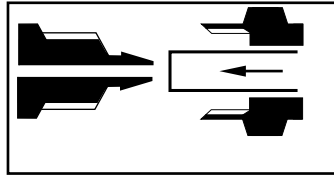

2. Place the knurled nut over the tube.

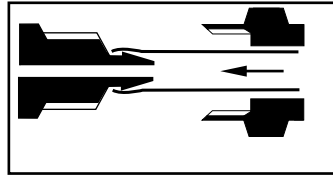

3. Push the tube over the barbed end of the fitting up to the tube stop.

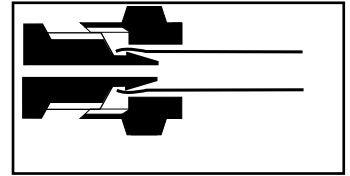

4. Screw the knurled nut onto the fitting until finger tight. The hexagon on the nut is to aid release.

Straight Male Adaptor

Tube to male taper
BSP thread

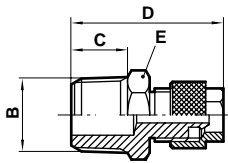

24125

Product number	For use with tube OD/ID	B	C	D	E A/F
241250418	4/2,5	1/8	7,5	23,0	12
241250518	5/3	1/8	7,5	23,0	12
241250618	6/4	1/8	7,5	25,6	12
241250628	6/4	1/4	11,0	29,6	14
241250638	6/4	3/8	11,5	30,0	17
241250818	8/6	1/8	7,5	26,9	14
241250828	8/6	1/4	11,0	30,9	14
241250838	8/6	3/8	11,5	31,4	17
241250848	8/6	1/2	14,0	34,0	22
241251018	10/8	1/8	7,5	29,0	14
241251028	10/8	1/4	11,0	33,0	14
241251038	10/8	3/8	11,5	33,5	17
241251048	10/8	1/2	14,0	36,5	22
241251238	12/10	3/8	11,5	35,0	17
241251248	12/10	1/2	14,0	38,0	22
241251548	15/12,5	1/2	14,0	40,0	22

Straight Male Adaptor

Tube to male BSP
Parallel thread

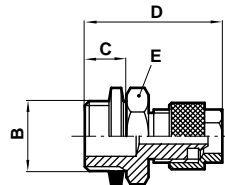

24225

Product number	For use with tube OD/ID	B	C	D	E A/F
242250418	4/2,5	1/8	6	21,5	13
242250518	5/3	1/8	6	24,1	13
242250618	6/4	1/8	6	24,1	13
242250628	6/4	1/4	8	26,6	17
242250638	6/4	3/8	9	27,6	19
242250648	6/4	1/2	10	30,0	24
242250818	8/6	1/8	6	25,4	14
242250828	8/6	1/4	8	27,9	17
242250838	8/6	3/8	9	28,9	19
242250848	8/6	1/2	10	30,0	24
242251018	10/8	1/8	6	27,5	14
242251028	10/8	1/4	8	30,0	17
242251038	10/8	3/8	9	31,0	19
242251048	10/8	1/2	10	32,5	24
242251238	12/10	3/8	9	32,5	19
242251248	12/10	1/2	10	34,0	24
242251548	15/12,5	1/2	10	36,0	24

Supplied complete with sealing washer

Straight Male Adaptor

Tube to male metric thread

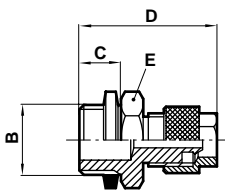

24225

Product number	For use with tube OD/ID	B	C	D	E A/F
242250405	4/2,5	M5	4	19,5	8
242250505	5/3	M5	4	22,1	8
242250605	6/4	M5	4	22,1	8

Supplied complete with sealing washer

Straight Female Adaptor

Tube to female BSP
parallel thread

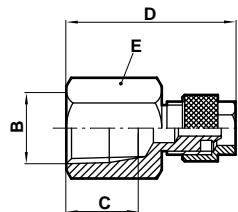

24226

Product number	For use with tube OD/ID	B	C	D	E A/F
242260618	6/4	1/8	7,5	23,3	14
242260628	6/4	1/4	11,0	27,0	17
242260638	6/4	3/8	11,5	28,0	22
242260818	8/6	1/8	7,5	24,7	14
242260828	8/6	1/4	11,0	28,7	17
242260838	8/6	3/8	11,5	29,2	22
242260848	8/6	1/2	15,0	33,0	24
242261028	10/8	1/4	11,0	30,5	17
242261038	10/8	3/8	11,5	33,3	22
242261048	10/8	1/2	15,0	34,5	24



Straight Connector

Tube to tube

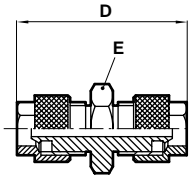

24020

Product number	For use with tube OD/ID	tube	D	E A/F
240200400	4/2,5		27,5	8
240200500	5/3		31,7	10
240200605	6/4	5/3	32,2	12
240200600	6/4		32,2	12
240200806	8/6	6/4	33,5	12
240200800	8/6		34,8	12
240201000	10/8		39,0	14
240201200	12/10		43,0	17
240201500	15/12,5		47,0	22

Bulkhead Connector

Tube to tube

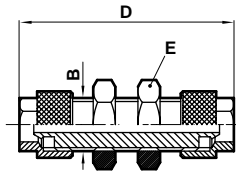

24029

Product number	For use with tube OD/ID	B	D	E A/F
240290400	4/2,5	M6x0,5	39,6	9
240290500	5/3	M7x0,75	39,6	9
240290605	6/4 x 5/3	M10x1	45,5	14
240290600	6/4	M10x1	45,5	14
240290806	8/6x 6/4	M12x1	47,3	17
240290800	8/6	M12x1	48,4	17
240291000	10/8	M14x1	54,0	17
240291200	12/10	M16x1	57,0	19
240291500	15/12,5	M20x1	59,0	24

Elbow Male Adaptor

Tube to male taper BSP thread

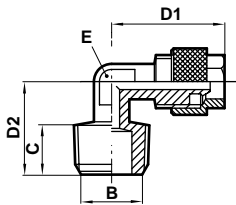

24145

Product number	For use with tube OD/ID	B	C	D1	D2	E A/F
241450418	4/2,5	1/8	7,5	18,5	15,0	8
241450518	5/3	1/8	7,5	18,5	15,0	8
241450618	6/4	1/8	7,5	18,5	15,0	8
241450628	6/4	1/4	11,0	20,6	19,0	8
241450638	6/4	3/8	11,5	21,0	20,5	9
241450818	8/6	1/8	7,5	19,9	16,5	9
241450828	8/6	1/4	11,0	21,9	19,0	9
241450838	8/6	3/8	11,5	23,4	21,0	9
241450848	8/6	1/2	14,0	23,4	28,0	16
241451018	10/8	1/8	7,5	24,0	18,0	11
241451028	10/8	1/4	11,0	24,0	22,0	11
241451038	10/8	3/8	11,5	25,5	22,0	11
241451048	10/8	1/2	14,0	25,5	28,0	16
241451238	12/10	3/8	11,5	27,0	22,5	13
241451248	12/10	1/2	14,0	27,0	28,0	16
241451548	15/12,5	1/2	14,0	31,5	28,0	16

Elbow Female Adaptor

Tube to parallel female BSP thread

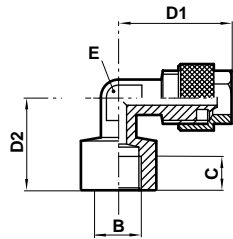

24246

Product number	For use with tube OD/ID	B	C	D1	D2	E A/F
242460518	5/3	1/8	7,5	20,6	18	8
242460618	6/4	1/8	7,5	20,6	18	8
242460628	6/4	1/4	11,0	21,2	21	9
242460818	8/6	1/8	7,5	21,9	19	9
242460828	8/6	1/4	11,0	23,4	21	9
242461028	10/8	1/4	11,0	25,5	22	11
242461038	10/8	3/8	11,5	25,5	25	14

Elbow Connector

Tube to tube

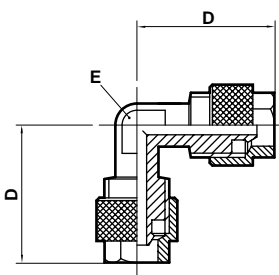

24040

Product number	For use with tube OD/ID	D	E A/F
240400400	4/2,5	20,0	8
240400500	5/3	20,6	8
240400600	6/4	20,6	8
240400806	8/6-6/4	21,9	9
240400800	8/6	21,9	9
240401000	10/8	25,5	11
240401200	12/10	27,0	13
240401500	15/12,5	33,5	16

Swivel Elbow Adaptor

Tube to male BSPP

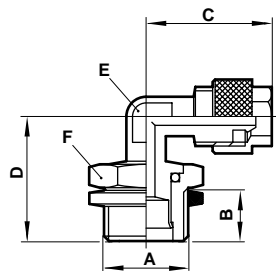

24247

Product number	For use with tube OD/ID	A BSPP	B	C	D	E A/F	F A/F
242470618	6/4	1/8	6	20,6	20	8	14
242470628	6/4	1/4	8	20,6	22	8	17
242470818	8/6	1/8	6	21,6	20	9	14
242470828	8/6	1/4	8	23,1	23	9	17
242471028	10/8	1/4	8	24	24	11	17

Supplied complete with sealing washer



Tee Male Adaptor
Tube to male taper
BSP centre leg

24165

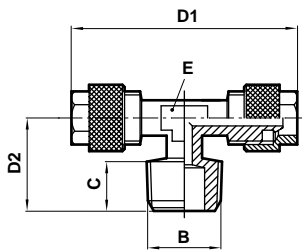

Product number	For use with tube OD/ID	B	C	D1	D2	E A/F
241650418	4/2,5	1/8	7,5	37,0	15,0	8
241650518	5/3	1/8	7,5	37,2	15,0	8
241650618	6/4	1/8	7,5	37,2	15,0	8
241650628	6/4	1/4	11,0	41,2	19,0	9
241650818	8/6	1/8	7,5	39,8	16,5	9
241650828	8/6	1/4	11,0	43,8	20,5	9
241651018	10/8	1/8	7,5	48,0	18,0	11
241651028	10/8	1/4	11,0	48,0	22,0	11
241651038	10/8	3/8	11,5	51,0	22,0	11
241651238	12/10	3/8	11,5	54,0	22,5	13
241651548	15/12,5	1/2	14,0	63,0	28,0	16

Tee Male Adaptor
Tube to male taper
BSP side leg

24175

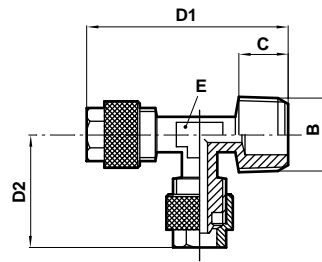

Product number	For use with tube OD/ID	B	C	D1	D2	E A/F
241750518	5/3	1/8	7,5	36,7	20,6	8
241750618	6/4	1/8	7,5	36,7	20,6	8
241750628	6/4	1/4	11,0	40,2	20,6	8
241750818	8/6	1/8	7,5	38,0	21,9	9
241750828	8/6	1/4	11,0	41,5	21,9	9
241751018	10/8	1/8	7,5	41,5	25,5	11
241751028	10/8	1/4	11,0	45,0	25,5	11
241751038	10/8	3/8	11,5	45,5	25,5	11
241751238	12/10	3/8	11,5	48,5	28,0	13
241751548	15/12,5	1/2	14,0	57,5	32,5	16

Tee Connector
Tube to tube

24060

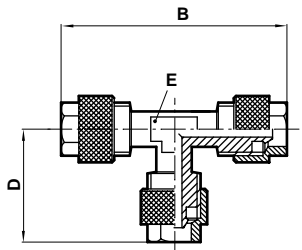

Product number	For use with tube OD/ID	B	D	E A/F
240600400	4/2,5	38,5	19,5	8
240600500	5/3	41,2	20,6	8
240600600	6/4	41,2	20,6	8
240600806	8/6 - 6/4	43,8	20,6	9
240600800	8/6	43,8	21,9	9
240601006	10/8 - 6/4	51,0	20,6	11
240601008	10/8 - 8/6	51,0	21,9	11
240601000	10/8	51,0	25,5	11
240601200	12/10	54,0	28,0	13
240601500	15/12,5	63,0	32,5	16

Equal Cross Connector
Tube to tube

24090

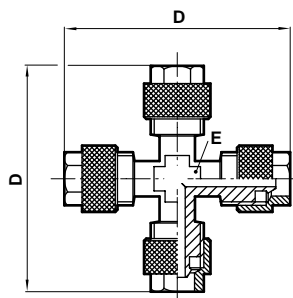

Product number	For use with tube OD/ID	D	E A/F
240900500	5/3	41,6	8
240900600	6/4	41,6	8
240900800	8/6	44,4	9
240901000	10/8	51,0	11
240901200	12/10	58,0	13
240901500	15/12,5	64,0	17

Single Banjo Body

24051

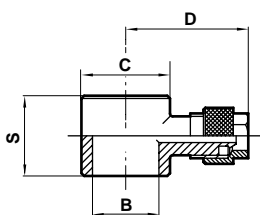

Product number	For use with tube OD/ID	Thread	B	C	S	D
240510405	4/2,5	M5	5,1	9,0	9,0	16,5
†240510406	4/2,5	M5	6,1	9,0	9,0	16,5
240510418	4/2,5	1/8	10,0	14,0	14,5	23,3
240510505	5/3	M5	5,1	9,0	9,0	16,5
†240510506	5/3	M5	6,1	9,0	9,0	16,5
240510518	5/3	1/8	10,0	14,0	14,5	23,3
240510605	6/4	M5	5,1	9,0	9,0	16,5
†240510606	6/4	M5	6,1	9,0	9,0	16,5
240510618	6/4	1/8	10,0	14,0	14,5	23,3
240510628	6/4	1/4	13,3	18,0	14,5	25,3
240510638	6/4	3/8	16,6	21,0	14,5	26,8
240510818	8/6	1/8	10,0	14,0	14,5	24,7
240510828	8/6	1/4	13,3	18,0	14,5	27,6
240510838	8/6	3/8	16,6	21,0	14,5	27,7
240510848	8/6	1/2	21,0	26,0	14,5	31,2
240511018	10/8	1/8	10,0	14,0	14,5	27,5
240511028	10/8	1/4	13,3	18,0	14,5	29,5
240511038	10/8	3/8	16,6	21,0	14,5	30,5
240511048	10/8	1/2	21,0	26,0	14,5	34,0
240511238	12/10	3/8	16,6	21,0	14,5	31,5
240511248	12/10	1/2	21,0	26,0	14,5	35,0
240511548	15/12,5	1/2	21,0	26,0	14,5	36,5

† to be used with bolts marked *alongside.

Double Banjo Body

24071

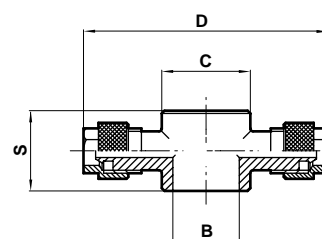

Product number	For use with tube OD/ID	B	C	S	D
240710405	4/2,5 - M5	5,1	9	9,0	33,0
240710418	4/2,5 - 1/8	10,0	14	14,5	46,6
240710505	5/3 - M5	5,1	9	9,0	33,0
240710518	5/3 - 1/8	10,0	14	14,5	46,6
240710605	6/4 - M5	5,1	9	9,0	33,0
240710618	6/4 - 1/8	10,0	14	14,5	46,6
240710628	6/4 - 1/4	13,3	18	14,5	50,6
240710638	6/4 - 3/8	16,6	21	14,5	53,6
240710818	8/6 - 1/8	10,0	14	14,5	49,4
240710828	8/6 - 1/4	13,3	18	14,5	55,2
240710838	8/6 - 3/8	16,6	21	14,5	55,4
240710848	8/6 - 1/2	21,0	26	14,5	61,0
240711018	10/8 - 1/8	10,0	14	14,5	53,0
240711028	10/8 - 1/4	13,3	18	14,5	59,0
240711038	10/8 - 3/8	16,6	21	14,5	61,0
240711048	10/8 - 1/2	21,0	26	14,5	68,0
240711238	12/10 - 3/8	16,6	21	14,5	63,0
240711248	12/10 - 1/2	21,0	26	14,5	70,0
240711548	15/12,5 - 1/2	21,0	26	14,5	73,0



Banjo Stem Single Short

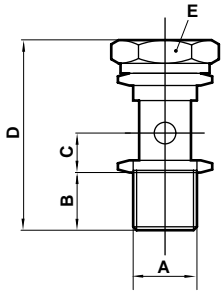

24A00

Product number	A	B	C	D	E A/F
24A000005	M5	4	4,5	18,0	8
24A000018	1/8	6	8,5	27,5	14
24A000028	1/4	8	8,5	30,0	17
24A000038	3/8	9	8,5	30,5	19
24A000048	1/2	10	8,5	31,5	24

Banjo Stem Double Short

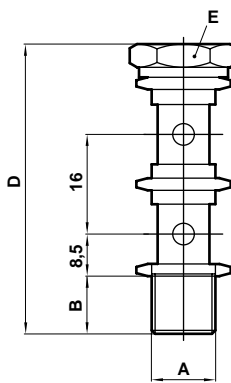

24B00

Product number	A	B	D	E A/F
24B000018	1/8	6	43,0	14
24B000028	1/4	8	46,0	17
24B000038	3/8	9	46,5	19
24B000048	1/2	10	47,5	24

Banjo Stem Triple Short

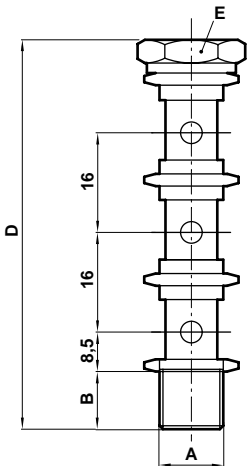

24C00

Product number	A	B	D	E A/F
24C000018	1/8	6	59,0	14
24C000028	1/4	8	62,0	17
24C000038	3/8	9	62,5	19
24C000048	1/2	10	63,5	24

Banjo Stem Single Long

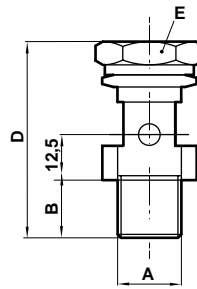

24A00

Product number	A BSPT	B	D	E A/F
24A00L018	1/8	6	31,0	14
24A00L028	1/4	8	33,5	17
24A00L038	3/8	9	34,5	19
24A00L048	1/2	10	35,5	24

Banjo Stem Double Long

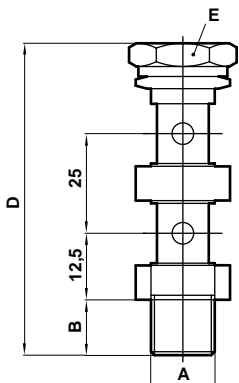

24B00

Product number	A	B	D	E A/F
24B00L018	1/8	6	56,0	14
24B00L028	1/4	8	58,5	17
24B00L038	3/8	9	59,5	19
24B00L048	1/2	10	60,5	24

Banjo Stem Triple Long

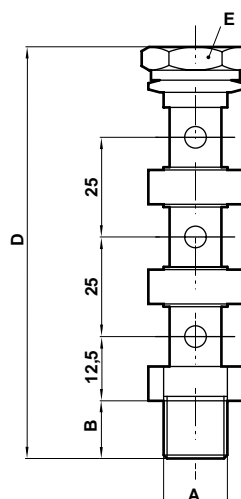

24C00

Product number	A	B	D	E A/F
24C00L018	1/8	6	81,0	14
24C00L028	1/4	8	83,5	17
24C00L038	3/8	9	84,5	19
24C00L048	1/2	10	85,5	24



Banjo Flow Regulators

Operating pressure 0 -10 bar

Adjustable Restrictor Valves 1/8 (DN2)
Supply pressure = 7 bar
 $\Delta p = 1$ bar

Adjustable Restrictor Valves 1/8 (DN2)
Supply pressure = 7 bar
 $p = 1$ bar

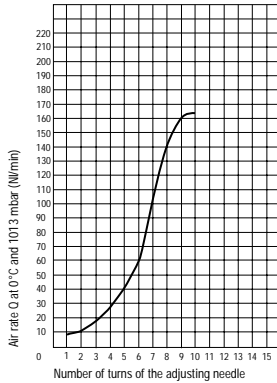

Adjustable Restrictor Valves 1/4 (DN3.5)
Supply pressure = 7 bar
 $\Delta p = 1$ bar

Adjustable Restrictor Valves 1/4 (DN3.5)
Supply pressure = 7 bar
 $p = 1$ bar

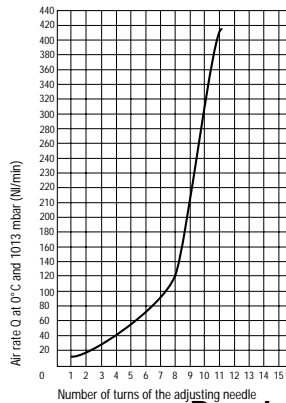

Adjustable Restrictor Valves M5 (DN1.5)
Supply pressure = 7 bar
 $\Delta p = 1$ bar

Adjustable Restrictor Valves M5 (DN1.5)
Supply pressure = 7 bar
 $p = 1$ bar

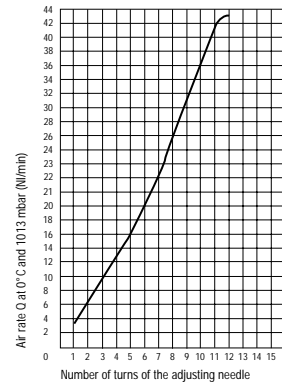

Flow Regulator regulating out

Screwdriver regulation

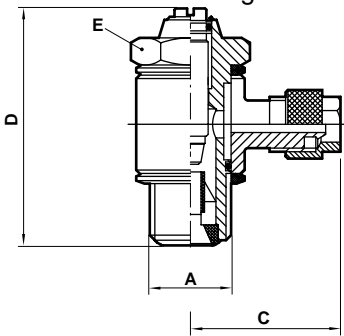

24K51

Product number	O/D tube	A	C	D	E A/F
24K510405	4/2,5	M5	16,5	24,0	8,0
24K510418	4/2,5	1/8	23,3	30,5	14,0
24K510605	6/4	M5	16,5	24,0	8,0
24K510618	6/4	1/8	23,3	30,5	14,0
24K510628	6/4	1/4	25,3	30,5	17,0
24K510818	8/6	1/8	24,7	30,5	14,0
24K510828	8/6	1/4	27,6	35,5	17,0
24K511028	10/8	1/4	29,5	35,5	17,0

Regulating out

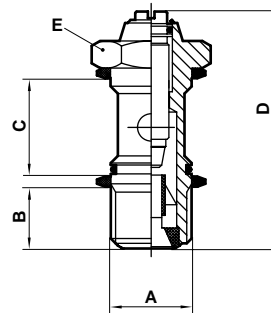

24K00

Product number	A	B	C	D	E A/F
*24K000005	M5	4,0	12,5	24,0	8,0
24K000018	1/8	5,5	14,5	30,5	14,0
24K000028	1/4	8,5	14,5	35,5	17,0

* to be used with bodies marked † alongside

Bi-directional flow

24M00

Product number	A	B	C	D	E A/F
*24M000005	M5	4,0	12,5	24,0	8,0
24M000018	1/8	5,5	14,5	30,5	14,0
24M000028	1/4	8,5	14,5	35,5	17,0

* to be used with bodies marked † alongside

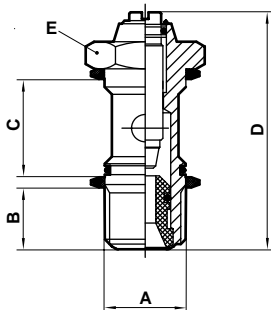

Regulating in

24L00

Product number	A	B	C	D	E A/F
*24L000005	M5	4,0	12,5	24,0	8,0
24L000018	1/8	5,5	14,5	30,5	14,0
24L000028	1/4	8,5	14,5	35,5	17,0

* to be used with bodies marked † alongside

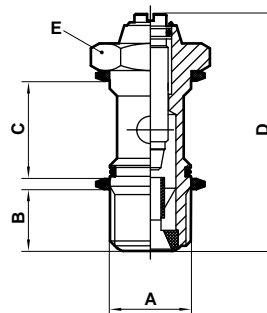



Elbow Banjo Assembly
Non regulating bolt

24A51

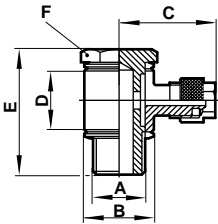

Product number	tube size	A thread	B	C	D	E	F A/F
24A510405	4/2,5	M5	9,0	16,5	9,0	18,0	8
24A510505	5/3	M5	9,0	16,5	9,0	18,0	8
24A510605	6/4	M5	9,0	16,5	9,0	18,0	8
24A510418	4/2,5	1/8	14,0	23,3	14,5	27,5	14
24A510518	5/3	1/8	14,0	23,3	14,5	27,5	14
24A510618	6/4	1/8	14,0	23,3	14,5	27,5	14
24A510818	8/6	1/8	14,0	24,7	14,5	27,5	14
24A510628	6/4	1/4	18,0	25,3	14,5	30,0	17
24A510828	8/6	1/4	18,0	27,6	14,5	30,0	17
24A511028	10/8	1/4	18,0	29,5	14,5	30,0	17
24A510638	6/4	3/8	21,0	26,8	14,5	30,5	19
24A510838	8/6	3/8	21,0	27,7	14,5	30,5	19
24A511238	12/10	3/8	21,0	31,5	14,5	30,5	19
24A511248	12/10	1/2	26,0	35,0	14,5	31,5	24

Supplied complete with sealing washer

Tee Banjo Assembly
Non regulating bolt

24A71

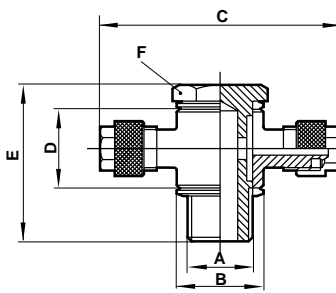

Product number	Tube size	A thr'd	B	C	D	E	F A/F
24A710405	4/2,5	M5	9,0	33,0	9,0	18,0	8
24A710505	5/3	M5	9,0	33,0	9,0	18,0	8
24A710605	6/4	M5	9,0	33,0	9,0	18,0	8
24A710418	4/2,5	1/8	14,0	46,6	14,5	27,5	14
24A710518	5/3	1/8	14,0	46,6	14,5	27,5	14
24A710618	6/4	1/8	14,0	46,6	14,5	27,5	14
24A710818	8/6	1/8	14,0	49,4	14,5	27,5	14
24A710628	6/4	1/4	18,0	50,6	14,5	30,0	17
24A710828	8/6	1/4	21,0	53,6	14,5	30,5	19
24A710638	6/4	3/8	21,0	53,6	14,5	30,0	17
24A710838	8/6	3/8	21,0	55,4	14,5	30,5	19
24A710848	8/6	1/2	26,0	61,0	14,5	31,5	24
24A711028	10/8	1/4	18,0	59,0	14,5	30,0	17
24A711238	12/10	3/8	21,0	63,0	14,5	30,5	19
24A711248	12/10	1/2	26,0	70,0	14,5	31,5	24

Supplied complete with sealing washer

Tubing Nut

24001

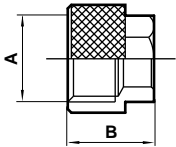

Product number	tube size	A thread	B
240010400	4/2,5	M6 x 0,5	10,0
240010500	5/3	M7 x 0,75	10,0
240010600	6/4	M10 x 1,0	11,0
240010800	8/6	M12 x 1,0	11,5
240011000	10/8	M14 x 1,0	13,5
240011200	12/10	M16 x 1,0	15,0
240011500	15/12,5	M20 x 1,0	16,0

Plug

24005

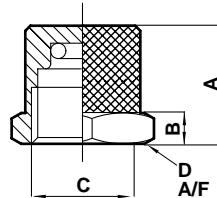

Product number	tube size	A	B	C thread	D A/F HEX
240050400	4/3	10,5	3,5	M6 x 0,5	8,0
240050600	6/4	11,5	4,0	M10 x 1,0	12,0
240050800	8/6	13,5	4,0	M12 x 1,0	14,0

Warning

These products are intended for use in industrial compressed air systems only. Do not use these products where pressures and temperatures can exceed those listed under 'Technical Data'.

Before using these products with fluids other than those specified, for non-industrial applications, life-support systems, or other applications not within published specifications, consult Norgren.

Through misuse, age, or malfunction, components used in fluid power systems can fail in various modes. The system designer is warned to consider the failure modes of all component parts used in fluid power systems and to provide adequate safeguards to prevent personal injury or damage to equipment in the event of such failure.

System designers must provide a warning to end users in the system instructional manual if protection against a failure mode cannot be adequately provided.

System designers and end users are cautioned to review specific warnings found in instruction sheets packed and shipped with these products where applicable.